









Este producto se compone de lo siguiente:

	1 pza	(A) Estructura para pupitre CLICK con asiento y respaldo
	4 pza	(B) Tuerca 1/4" hexagonal negra
	4 pza	(C) Tornillo de 1/4" x 1 1/4" cabeza botón allen negra
	1 pza	(D) Paleta estándar LPAP 19 mm para pupitre ESCOLARE 55*30 con insertos
	3 pza	(E) Bisagra plástica con logotipo para pupitres
	1 pza	(F) Portapaleta desmontable para pupitre CLICK/CLICK PLUS en tubular redondo 5/8" calibre 16
	6 pza	(G) Tornillo de 1/4" x 3/4" cabeza cilíndrica allen negra
	1 pza	(H) Canastilla desmontable para pupitre CLICK/CLICK PLUS en sólido redondo de 1/4" y de 3/16"

Tamaño Real para Verificar

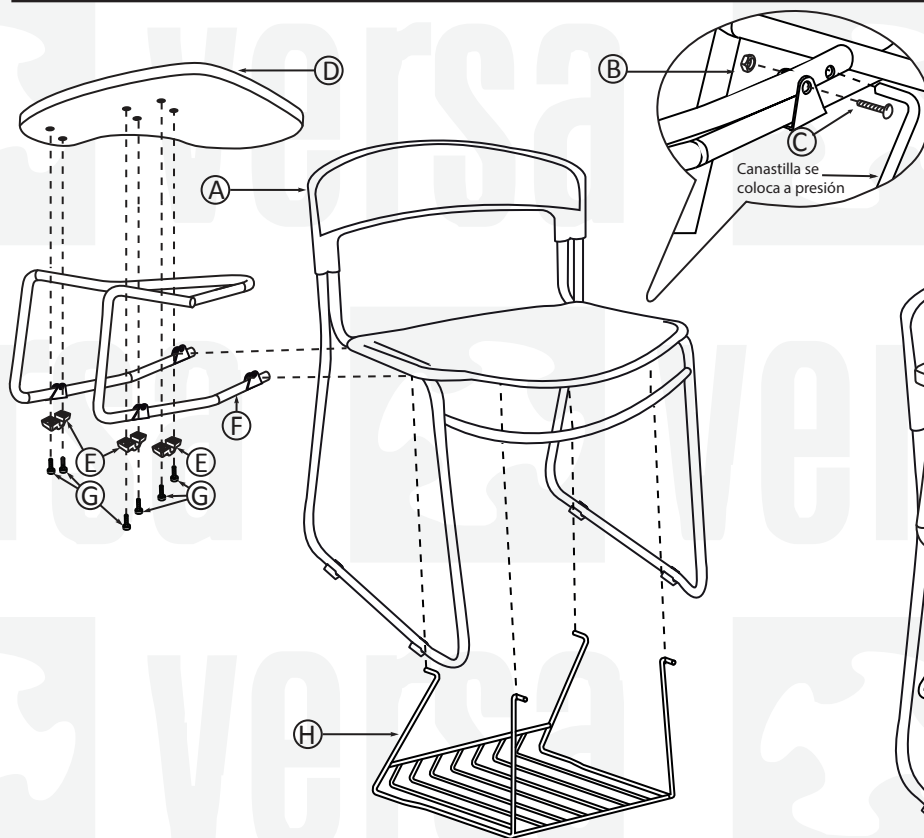
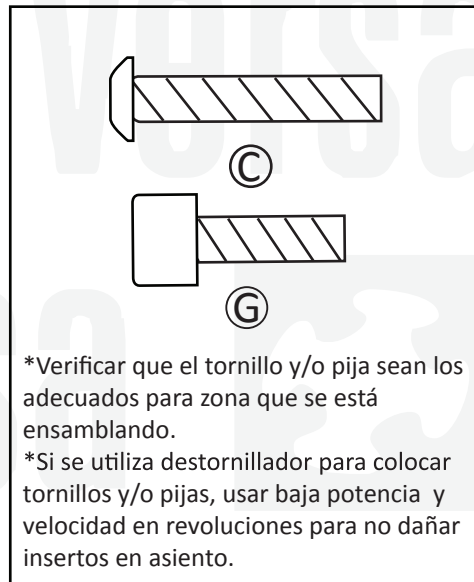

HERRAMIENTAS:

- * Llave Allen o destornillador con torque controlado
- * Martillo de goma

OJO no utilizar las siguientes herramientas:

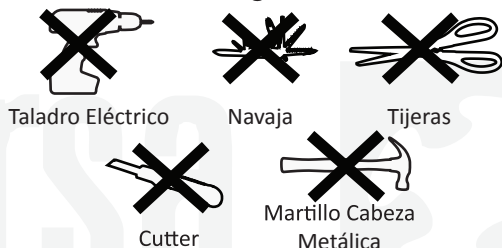

CNC

VERSIÓN
00

PÁGINA:
1 - 1