







Este producto se compone de lo siguiente:

	1 pza	(A) Asiento
	1 pza	(B) Respaldo
	1 pza	(C) Brazo derecho
	1 pza	(D) Brazos izquierdo
	8 pza	(E) Tornillo 6x20 mm cabeza hexagonal allen con rondana estriada integrada
	4 pza	(F) Tornillo 6x20 mm cabeza botón allen

Tamaño Real para Verificar

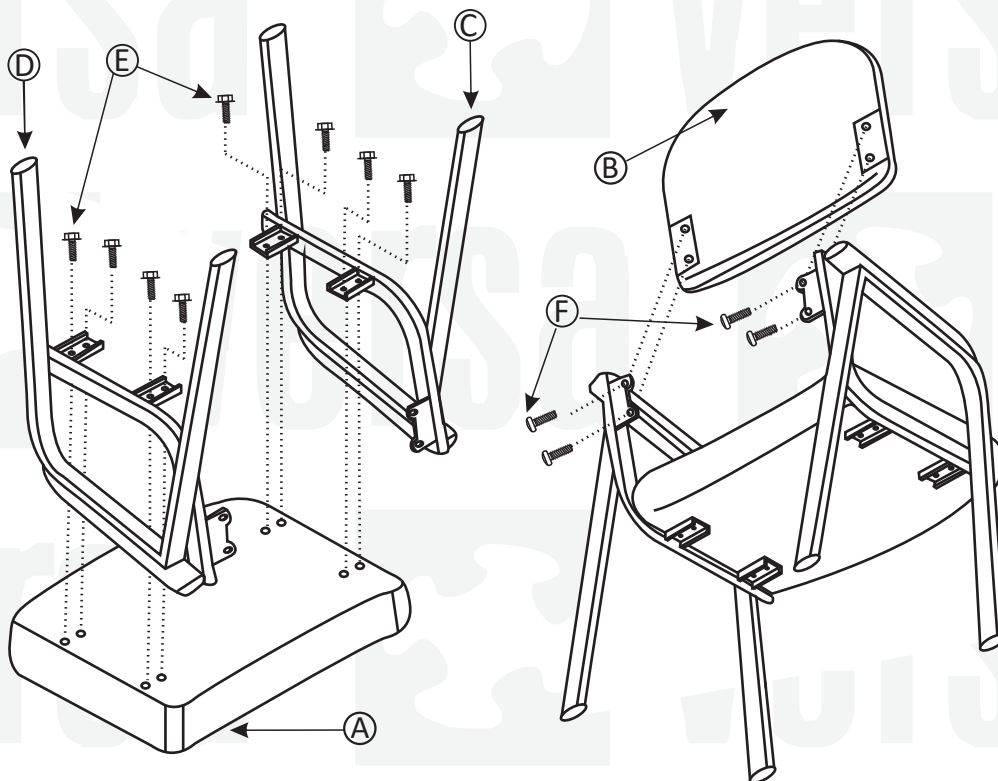
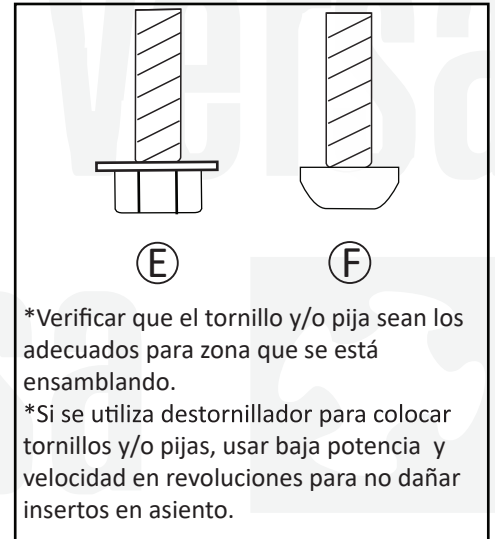

HERRAMIENTAS:

- * Llave Allen o destornillador con torque controlado
- * Martillo de goma

OJO no utilizar las siguientes herramientas:

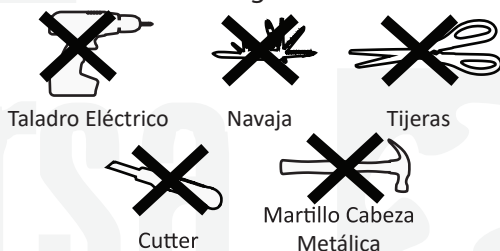

CNC

VERSIÓN
01

PÁGINA:
1 DE 1

ENSAMBLADO EN MÉXICO