







Este producto se compone de lo siguiente:

	1 pza	Ⓐ Respaldo
	1 pza	Ⓑ Pistón cromado
	1 pza	Ⓒ Cubre Pistón
	1 pza	Ⓓ Estrella cromada con rodajas
	1 pza	Ⓔ Asiento con mecanismo y brazos
	3 pza	Ⓕ Tornillo 8x20 mm cabeza hexagonal allen con rondana integrada negro

Tamaño Real para Verificar

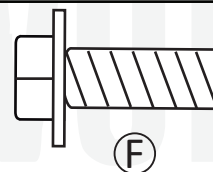

*Verificar que el tornillo y/o pija sean los adecuados para zona que se está ensamblando.

*Si se utiliza destornillador para colocar tornillos y/o pijas, usar baja potencia y velocidad en revoluciones para no dañar insertos en asiento.

HERRAMIENTAS:

* Llave Allen o destornillador con torque controlado

* Martillo de goma

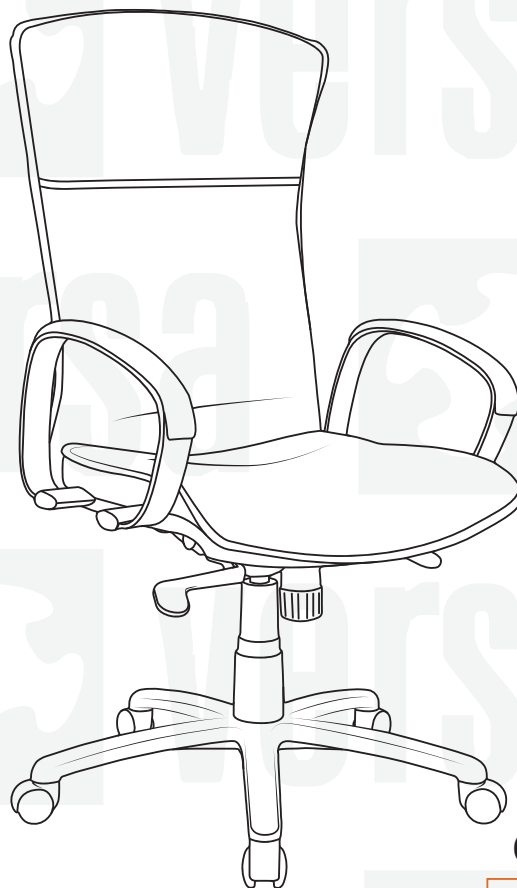
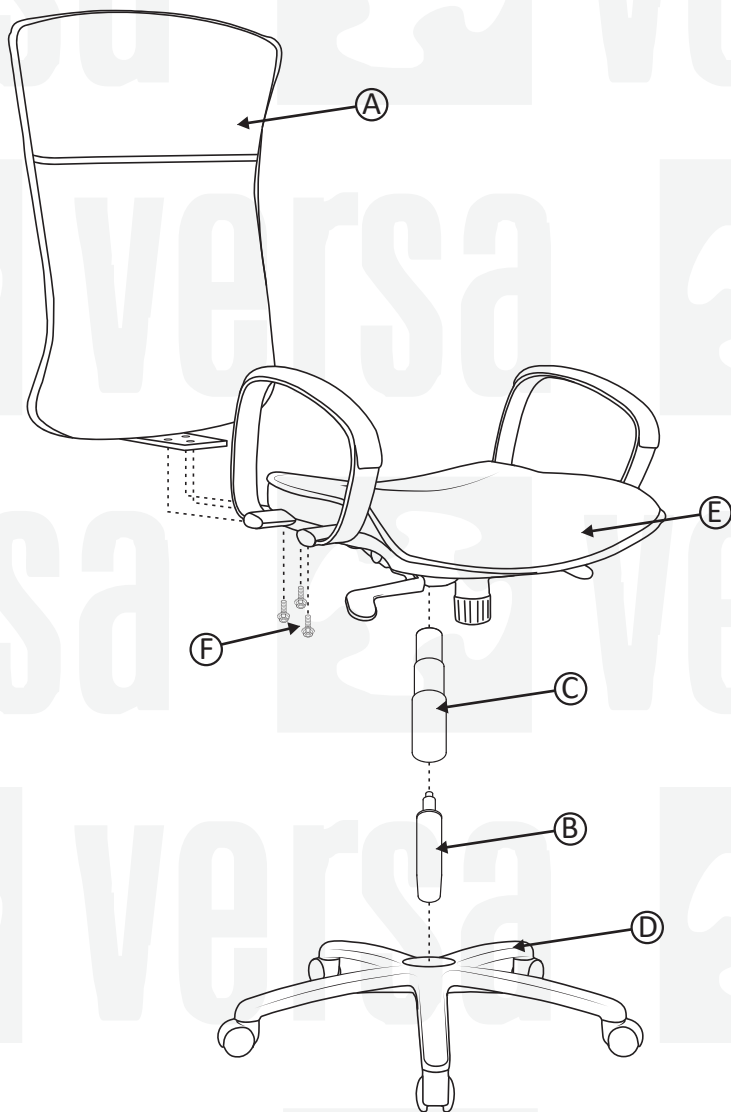

CNC

VERSIÓN
01

PÁGINA:

1 DE 1



Cutter



Taladro Eléctrico



Navaja



Tijeras



Martillo Cabeza
Metálica

OJO no utilizar las siguientes herramientas:

ENSAMBLADO EN MÉXICO